

Description

The DCSM24CL is a bi-directional TVS diode array, utilizing leading monolithic silicon technology to provide fast response time and low ESD clamping voltage, making this device an ideal solution for protecting sensitive semiconductor components from damage. The DCSM24CL complies with the IEC 61000-4-2 (ESD) standard with $\pm 30\text{kV}$ air and $\pm 30\text{kV}$ contact discharge. It is assembled into a lead-free SOT-23 package. It is designed to protect components which are connected to data and transmission lines from voltage surges.

Features

- ◆ Protects two uni-directional lines
- ◆ Ultra low leakage: nA level
- ◆ Operating voltage: 24V
- ◆ Low clamping voltage
- ◆ Complies with following standards:
 - IEC 61000-4-2 (ESD) immunity test
 - Air discharge: $\pm 30\text{kV}$
 - Contact discharge: $\pm 30\text{kV}$
 - IEC61000-4-5 (Lighting) 3A (8/20 μs)
- ◆ RoHS Compliant

Mechanical Characteristics

- ◆ Package: SOT-23
- ◆ Lead Finish: Matte Tin
- ◆ Case Material: "Green" Molding Compound.
- ◆ Moisture Sensitivity: Level 3 per J-STD-020
- ◆ Terminal Connections: See Diagram Below
- ◆ Marking Information: See Below

Applications

- ◆ Cellular Handsets and Accessories
- ◆ Notebook and Handhelds
- ◆ Portable Instrumentation
- ◆ Set Top Box
- ◆ Industrial Controls
- ◆ Server and Desktop PC

Dimensions and Pin Configuration

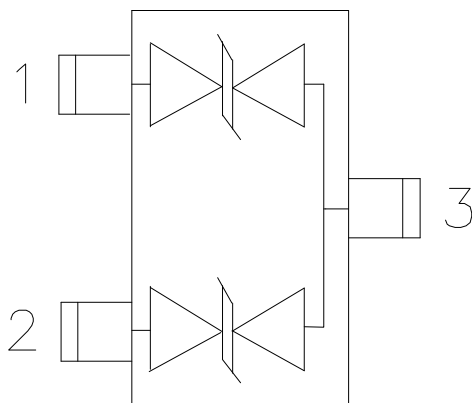

Circuit and Pin Schematic

Marking Information

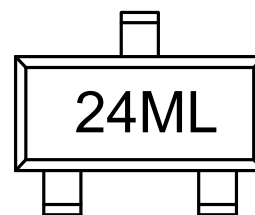

24ML = Device Marking Code

Ordering Information

Part Number	Marking	Packaging	Reel Size
DCSM24CL	24ML	3000/Tape & Reel	7 inch

Absolute Maximum Ratings ($T_A=25^{\circ}\text{C}$ unless otherwise specified)

Parameter	Symbol	Value	Unit
Peak Pulse Power (8/20 μs)	Ppk	150	W
Peak Pulse Current (8/20 μs)	Ipp	3	A
ESD per IEC 61000-4-2 (Air) ESD per IEC 61000-4-2 (Contact)	VESD	± 30 ± 30	kV
Operating Temperature Range	TJ	-55 to +125	$^{\circ}\text{C}$
Storage Temperature Range	Tstg	-55 to +150	$^{\circ}\text{C}$

Electrical Characteristics ($T_A=25^{\circ}\text{C}$ unless otherwise specified)

Parameter	Symbol	Min	Typ	Max	Unit	Test Condition
Reverse Working Voltage	VRWM			24	V	
Breakdown Voltage	VBR	27			V	IT = 1mA
Reverse Leakage Current	IR			0.2	μA	VRWM = 24V
Clamping Voltage	VC		33	36	V	I _{PP} = 1A (8 x 20 μs pulse)
Clamping Voltage	VC		41	50	V	I _{PP} = 3A (8 x 20 μs pulse)
Junction Capacitance	CJ		9		pF	VR = 0V, f = 1MHz, Pin 1 to Pin 3 or Pin 2 to Pin 3
Junction Capacitance	CJ		4		pF	VR = 0V, f = 1MHz, Pin 1 to Pin 2

Typical Performance Characteristics (TA=25°C unless otherwise Specified)

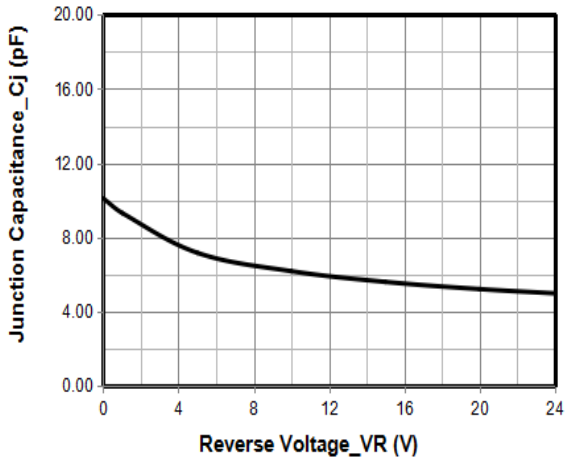

Junction Capacitance vs. Reverse Voltage

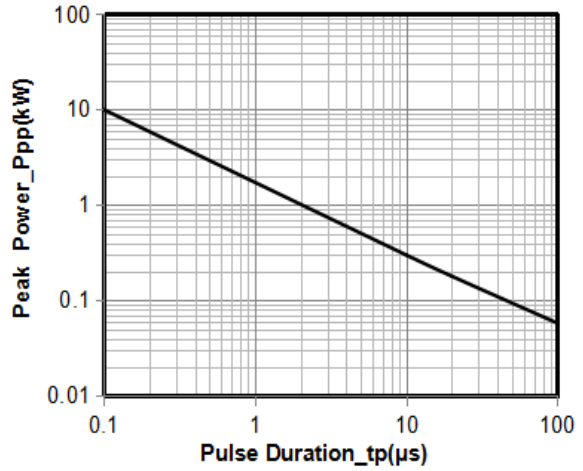

Peak Pulse Power vs. Pulse Time

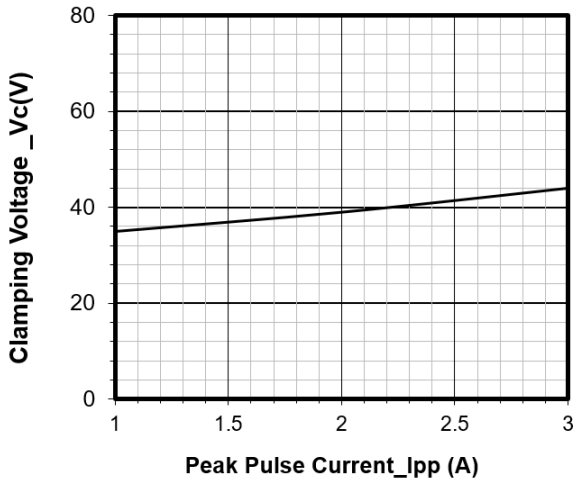

Clamping Voltage vs. Peak Pulse Current

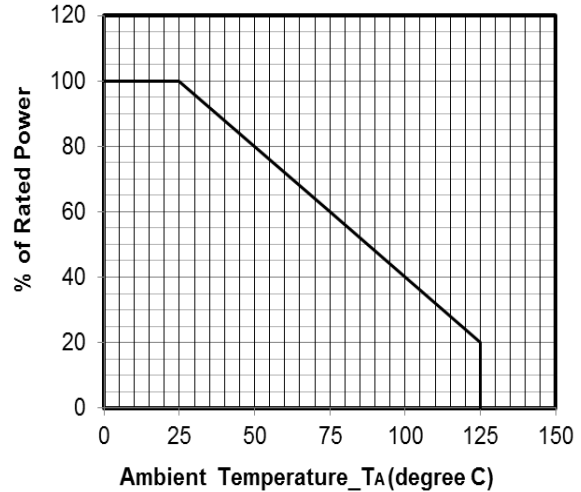

Power Derating Curve

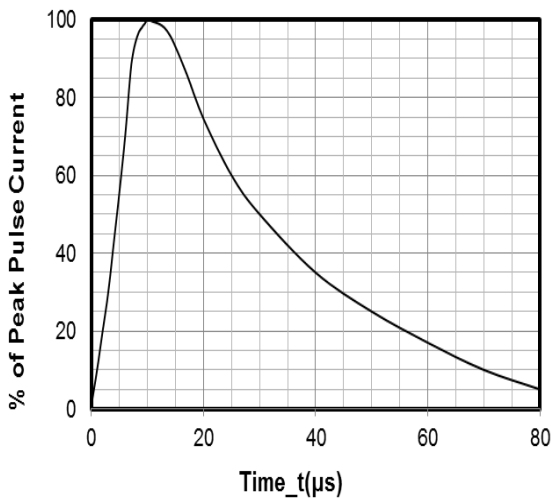

8 X 20μs Pulse Waveform

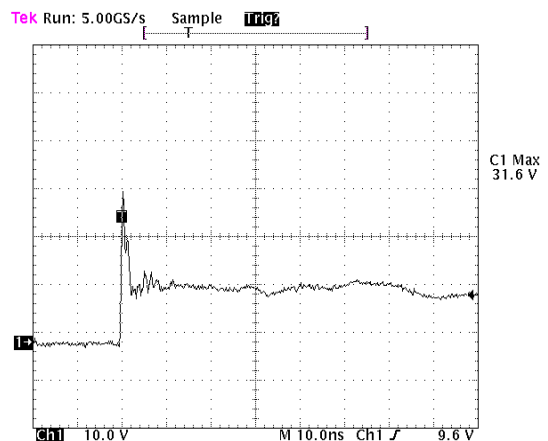

Note: Data is taken with a 10x attenuator

**ESD Clamping Voltage
8 kV Contact per IEC61000-4-2**

SOT-23 Package Outline Drawing

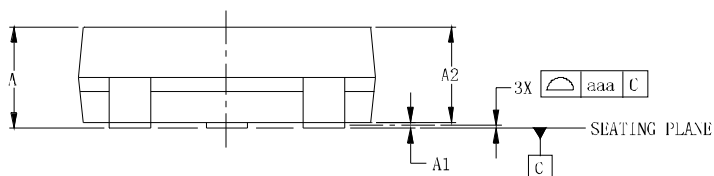
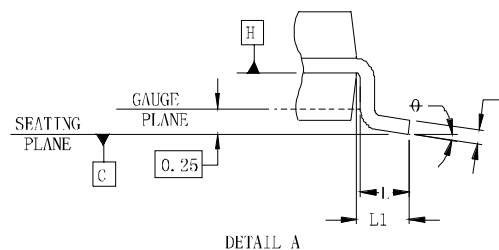
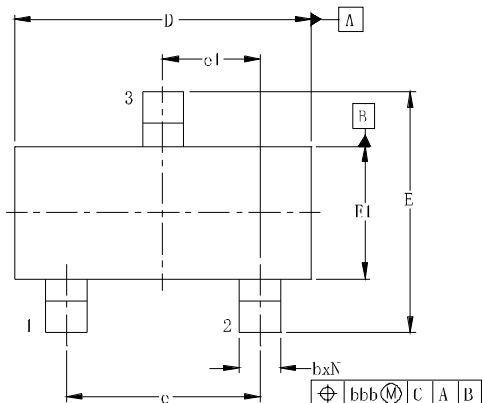

Suggested Land Pattern

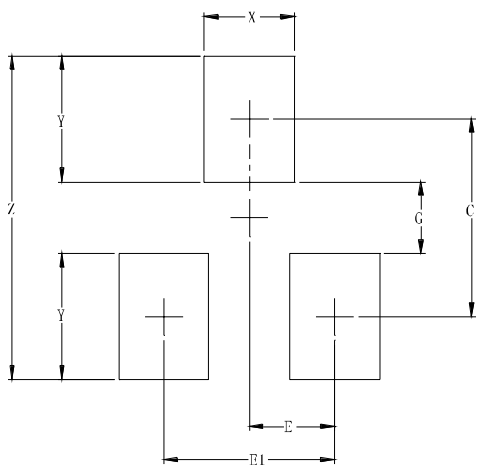

Contact Information

Changzhou D-first Electronics CO.,Ltd.

www.first-electronic.com

Email: xhf@first-electronic.cn

Phone: +86 (0519) 8817 1671

DIMENSIONS						
SYM	INCHES			MILLIMETERS		
	MIN	NOM	MAX	MIN	NOM	MAX
A	0.035	-	0.044	0.89	-	1.12
A1	0.000	-	0.004	0.01	-	0.10
A2	0.035	0.037	0.040	0.88	0.95	1.02
b	0.012	-	0.020	0.30	-	0.51
c	0.003	-	0.007	0.08	-	0.18
D	0.110	0.114	0.120	2.80	2.90	3.04
E	0.082	0.093	0.104	2.10	2.37	2.64
E1	0.047	0.051	0.055	1.20	1.30	1.40
e	0.075			1.90BSC		
e1	0.037			0.95BSC		
L	0.015	0.020	0.024	0.40	0.50	0.60
L1	0.022			0.55		
N	3			3		
ϕ	0°	-	8°	0°	-	8°
aaa	0.004			0.10		
bbb	0.008			0.20		

DIMENSIONS		
SYM	INCHES	MILLIMETERS
C	0.087	2.20
E	0.037	0.95
E1	0.075	1.90
G	0.031	0.80
X	0.039	1.00
Y	0.055	1.40
Z	0.141	3.60